

Ultravation®  
**UVMatrix™**

INDOOR AIR QUALITY (IAQ) IMPROVEMENT PRODUCTS  
ENERGY USE OPTIMIZATION  
LARGE AIR HANDLER APPLICATIONS

COMMERCIAL  
INSTITUTIONAL  
MEDICAL  
MANUFACTURING

**Ultravation®**

Better Air | Better Water | Better Living™





Since 1935 ultraviolet light has been used for disinfection for a variety of applications including air treatment. It has gained a reputation for being a cost effective and environmentally friendly disinfection technology.

- HVAC airstream exposure to germicidal UV can reduce all types of airborne pathogen counts throughout an air conditioned space.
- UV provides high-operating efficiency by way of its consistent prevention of bio-growth on HVAC components.
- UV-C disinfection reduces or completely eliminates the need for other types of system / cooling coil cleaning.
- Runtime is reduced through maintained optimized HVAC heat transfer.
- HVAC surface disinfection eliminates the HVAC system as a significant source of odors and unhealthful air contamination.

As specialists in improving indoor environments, we offer additional technologies — including ionization — to create complete IAQ solutions. Over the last thirty-five years, the people at the heart of Ultravation have been working together to study, engineer and manufacture products that improve people's well being, creating safer, more productive working environments with the added benefit of reducing the overall environmental impact HVAC systems.

— Scott Russell, President and Founding Partner

**Ultravation**<sup>®</sup>

Better Air | Better Water | Better Living™

# Bio-growth in HVAC systems is inevitable

## UV-C light is the cost effective and sustainable solution



Air conditioning has brought great benefits to people in terms of productivity in the workplace and making our lives far more comfortable at home as well. It has become ubiquitous and fully integrated into everyday life.

As air conditioning came into use, the need to maintain the equipment became necessary to keep the air flowing smoothly and drain pans from clogging.

UV is effective, energy saving and the only method that continually keeps bio-growth from taking hold in the constantly wet coils, drain pans and other moist areas which are ideal breeding ground for microbes.

Ultravation® also manufactures both HVAC airstream disinfection and convection-driven upper room products that have been suggested by the American Society of Heating, Refrigerating and Air-Conditioning Engineers (ASHRAE). They emit pure 254NM UV-C (UVGI) with no production of ozone.



Better Air | Better Water | Better Living™

# UV light is nature's way of controlling bio-growth

## Natural UV light controls microbial populations outdoors. UVMatrix™ brings UV inside.

It has been shown that even a thin bio-film measuring just a few thousandths of an inch on a cooling coil can reduce HVAC efficiency by 30% to 50% – as well as cause HVAC odors. Adding germicidal UV with intensity far beyond that found outdoors is well worth consideration for maintaining the efficiency and cleanliness of an HVAC system.

### Non-chemical sustainability

UV light does not pose a threat to the environment and consumables are recyclable.

### UV-C short wave ultraviolet light generates no ozone

Ultravation UV lamps are focused at the most lethal wave length of UV light – the UV-C range – and specifically centered on 254nm. It is possible for UV to generate ozone, it does so at the lower frequency of 185nm which is not emitted by Ultravation UV lamps for disinfection.

### Ultravation UV is 40% more intense with two-year (18,000 hr) UV lamp life

40% additional UV intensity over typical UV installations by **Ultravation's T3 UV Lamp technology**. The UV lamps are encased in water-tight transparent quartz sleeves that insulate the lamp, optimizing operating temperature. UV intensity is raised and lamp life is doubled *without additional power consumption*.

### Real time monitoring

Sensors that monitor actual UV intensity are available that provide assurance of needed UV-C dose at all times. Available for all UVMatrix products.



### Microbials killed by UV-C light

- |                        |                  |                        |                         |                            |                        |
|------------------------|------------------|------------------------|-------------------------|----------------------------|------------------------|
| Bacteria               | Ragweed          | Humidifier Fever       | Neoformans              | Mycrobacterium aviumintra  | Neisseria meningitidis |
| Viruses                | Dust mites       | Microplasma pneumoniae | Mucor                   | Streptococcus pyogenes     | Moraxella              |
| Legionella pneumophila | Measles          | Penicillium expensum   | Aspergillus niger       | Bacillus anthracis         | Acinetobacter          |
| Molds                  | Tuberculosis     | Cryptococcus           | Adenovirus              | Corynebacterium diphtheria | Haemophilus influenzae |
| Fungi                  | Chicken Pox      | Stachybotrys atra      | Coxsackievirus          | Serratia marcescens        | Pseudomonas aeruginosa |
|                        | SARS Coronavirus |                        | Mycrobacterium kansasii |                            |                        |

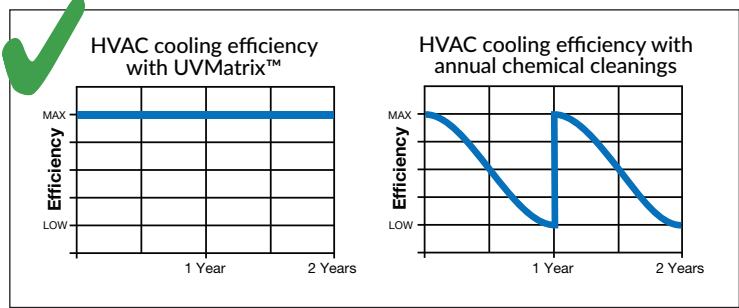

**Continually clean and efficient:** Without UV, manual / chemical cleanings are needed to restore efficiency, but performance begins to degrade almost immediately. Peak operation is limited. UV disinfection maintains peak efficiency for substantial energy conservation.

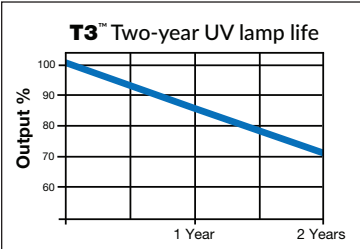
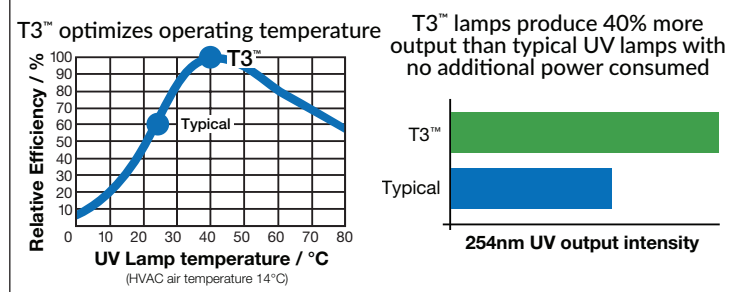

T3™ design encases UV lamps in protective quartz glass sleeves that insulate the lamp from the cold HVAC airstream, allowing them to operate at optimum temperature.

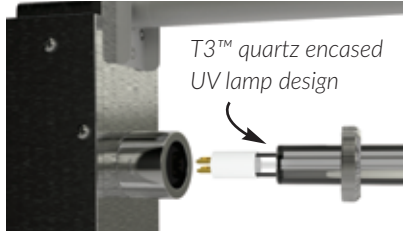

### Warranty

Ultravation® UVMatrix™ commercial application products are covered by Ultravation's Lifetime Warranty\*  
\*when used with genuine Ultravation UV lamps

Ultravation®  
**UVMatrix™ SI**

# HVAC coil and interior surface disinfection

The **UVMatrix SI-Series** is an innovative UV equipment design that stresses germicidal effectiveness as well as HVAC energy efficiency. It is also engineered to facilitate installation, maintenance, longevity and a low cost of ownership.

- Built-in expansion system assures excellent fit and UV exposure
- Stainless steel construction available
- Complete system — no extra framework or hardware to purchase
- Rapid return on investment
- Reduces wear and tear, extends HVAC lifespan
- Complete assessment and sizing service provided



Ultravation SI Series is protected under U.S. Patent #7419642B2

**UVMatrix™ CP** system monitoring with elapsed time display and available real-time UV-C intensity display with individual lamp performance sensors and remote alarm triggers.

**Factory techs available for installation:** Ultravation engineers are available to assist with specifying product configuration and sizing, as well as provide on site installation.



Better Air | Better Water | Better Living™

Expands to fit any HVAC system, new or retrofit

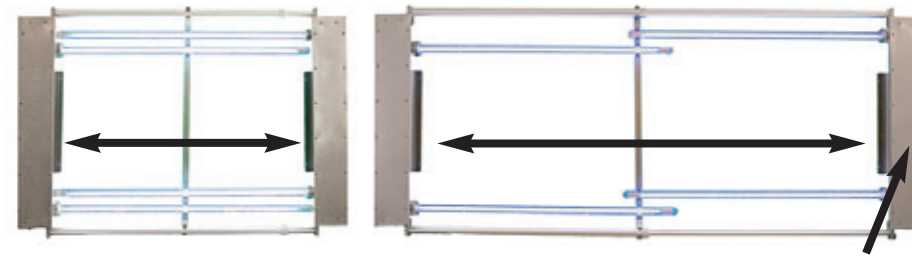

The SI-Series extends for perfect fit — sliding adjustability widens for exact fit! Ensures optimized UV coverage for all air handlers. Ships disassembled in a compact carton with 15 minute assembly procedure.

The SI-Series is self-contained and does not need additional framework or hardware.

## 360° UV-C dispersion maximizes HVAC surface coverage plus airstream disinfection

Results of airstream disinfection from a UVMatrix™ SI installation

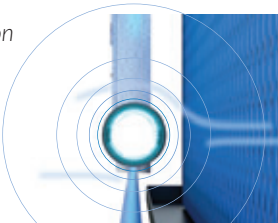
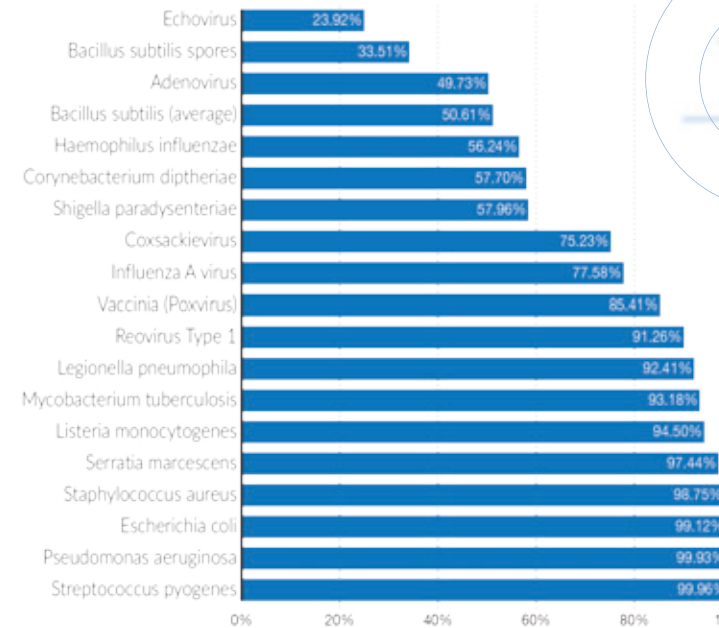

**Low turbulence T3™ UV lamp design** requires no reflective panels on the lamps, extending disinfection 360° for complete coil exposure plus adjacent surfaces — and the airstream itself.



T3™ temperature optimized UV lamps with water-tight connections for tolerance of wet HVAC environments.

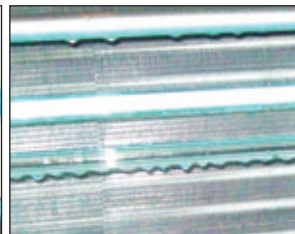

Condensate accumulates on UV lamps and frame

## UVMatrix™ SI-Series Energy Reduction Results

Measured benefits from adding UV to a clogged HVAC system — from an independent study

### System Performance Factors

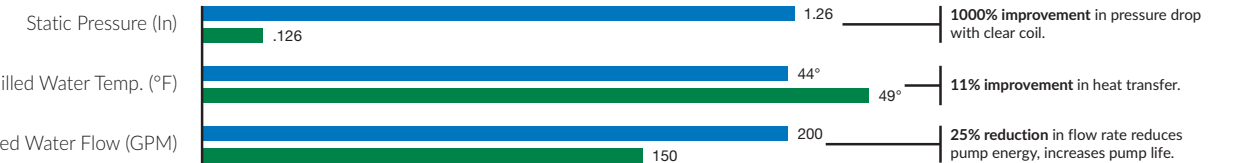

### Energy Used kWh/yr.



Net Energy Savings  
**112,075 kWh or \$13,090**  
 Electric rate @ \$0.1168 kWh

An independent study conducted by and copyright © B. Alan Whitson Company

Ultravation®  
**UVMatrix™ AS** airstream disinfection  
 for healthier working environments

The UVMatrix™ AS-Series is capable of exposing airborne microorganisms circulating through an HVAC system to high levels of UV-C energy. A major benefit of HVAC airstream disinfection is the reduction of airborne bacteria and viruses that accumulate in one area from being spread to other areas of the building. Another is the ability to apply a very intense germicidal dose with needed exposure or dwell time since people are completely shielded from the germicidal UV light.

**Ultravation®**  
 Better Air | Better Water | Better Living™

**T3™** T3™ temperature optimized, high intensity UV-C lamps

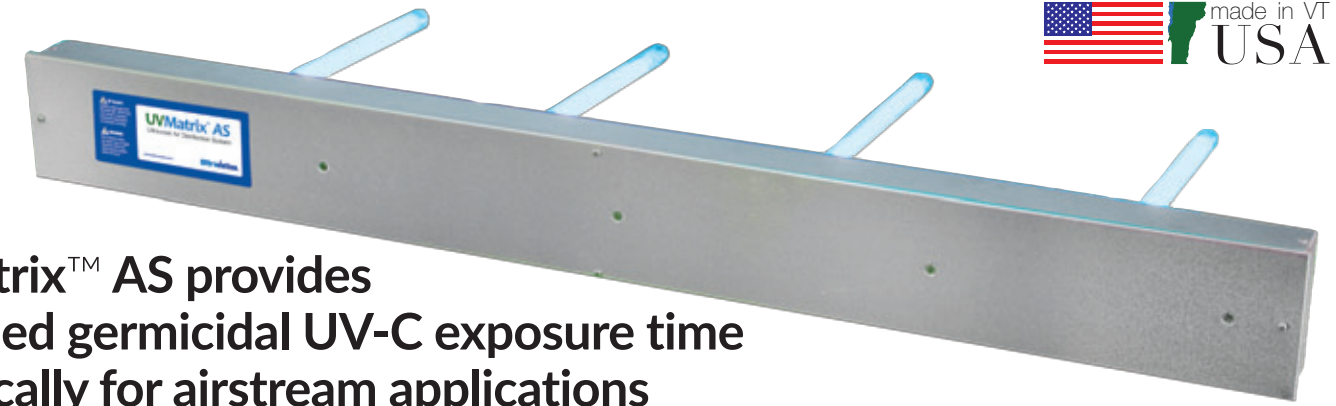

**UVMatrix™ AS provides extended germicidal UV-C exposure time specifically for airstream applications**

The AS-Series can be configured for nearly any airstream disinfection task. It is often used in tandem with UVMatrix SI as an efficient, unified system that provides coil and surface irradiation while efficiently combining the airstream disinfection of both systems.

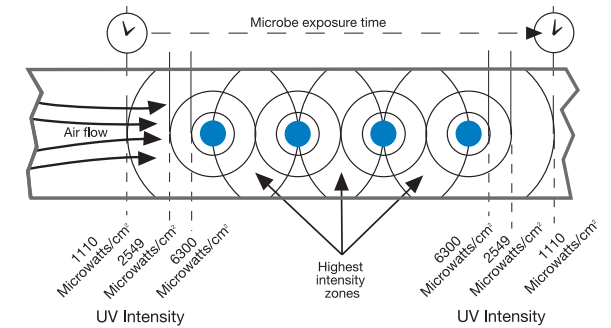
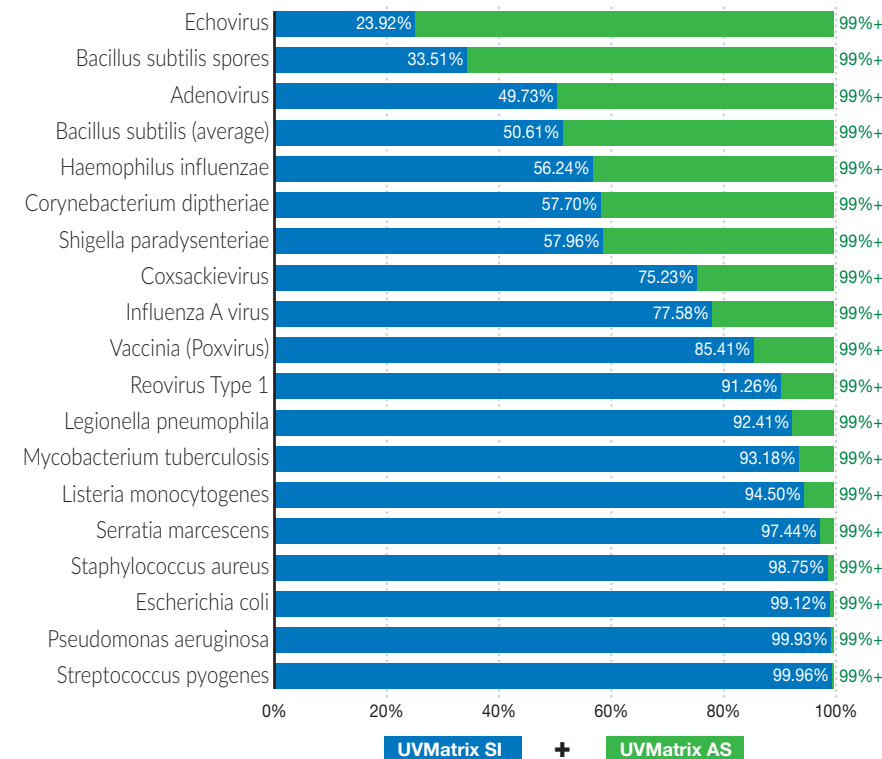

**Getting the right UV dose:** Ultraviolet light disinfection effectiveness is based on UV intensity and duration of exposure. UVMatrix™ AS installs in-line along the ductwork to obtain necessary contact or dwell time. Pre and post testing can be performed to confirm performance. Realtime UV intensity monitoring is available.

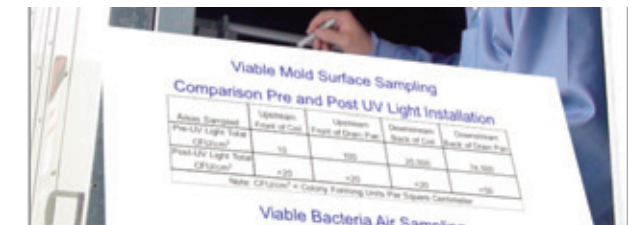

Factory technicians are available for HVAC analysis and UV system installation

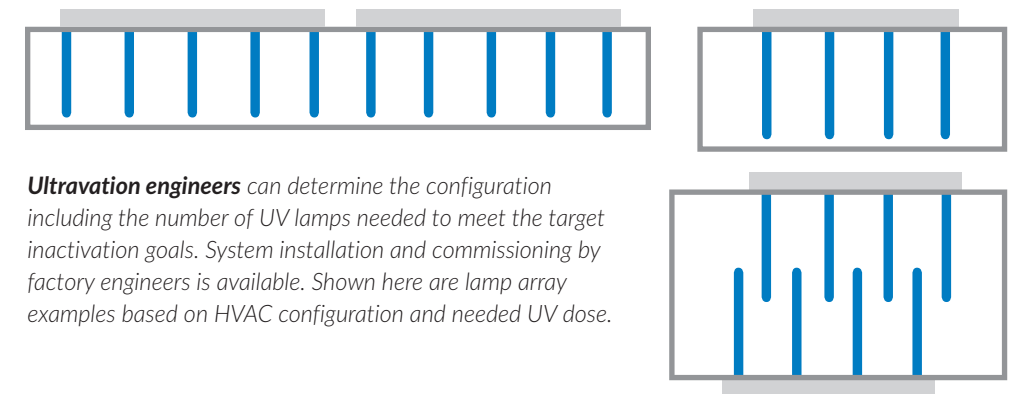

# Ultravation® UVMatrix™ LCI modular UV-C disinfection

## Independent testing confirms disinfection performance

Viral challenge studies were designed by the independent testing firm **Innovative Bioanalysis, Inc. of Costa Mesa, California**, to determine the efficacy of the **Ultravation LCI UV-C** air and surface disinfection system against coronaviruses, specifically SARS-CoV-2. The validation of the results was confirmed in testing following industry and ASHRAE recommendations and guidelines. The results showed that **99.99% of the SARS-CoV-2 virus was deactivated within 2 seconds of exposure** (see full report data at Ultravation.com).

**Real-time 254nm UV Monitoring:** UV-C intensity and operational live monitoring available. Can be integrated with building automation.

**Ultravation UVMatrix LCI-Series is a breakthrough in flexibility in UVGI for HVAC air handlers.** Available in 2, 4 and 6-lamp configurations that can be combined for complete germicidal coverage of any cooling coil configuration. UVMatrix LCI is a highly efficient solution to achieve target performance for surface disinfection (coils, drain pan, blower) and is easily configured for in-duct airstream disinfection (see facing page).

### Modular design/build:

Choose from 33-, 44- and 64-inch Ultravation® T3™ UV-C lamps.

### Remote, water-tight power cabinet:

All lamps powered from a single power source installed inside or outside the air handler.

### The ultimate in flexibility:

Install different UV-C lamp lengths as needed using the same power enclosure.

### Design flexibility for perfect fit and optimized UV-C coverage

The design flexibility of the UVMatrix LCI system allows for multiple lamp lengths to be used by the same enclosure for optimized UV-C coverage. Modular frame design with aluminum supports are pre-drilled for accurate lamp positioning / adjustable length assures fit with any coil with no cutting needed.

### Customizable 20 ft. UV-C lamp leads:

Easily create clean cable runs while maintaining fast and efficient installation.

### Lamp mount options:

Fasten lamps to vertical supports with strong magnets or aluminum brackets.



**NEMA-4X rated** electrical cabinet for operation outdoors and in wet areas. The cabinet is fiberglass and weather-tight for corrosion resistance.



**Easily accessed connections** to electronic smart-power supplies.

**Ultravation®**

Better Air | Better Water | Better Living™

## All UVMatrix LCI UV systems are assembled from these fundamental components

Adjustable UV-C lamp supports

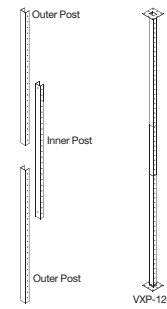

**VXP-120**  
Adjustable without cutting up to 120"  
(At least two posts required for any installation)

Water-tight electrical cabinet

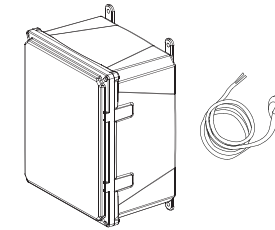

**LCI-2 • LCI-4 • LCI-6**  
2-, 4-, and 6-Lamp LCI Power Enclosure

**NEMA 4X rated**  
20 ft. UV lamp leads included

T3™ 254nm UV-C lamps

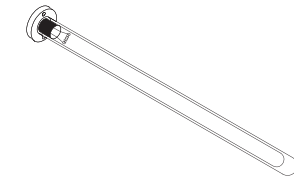

**AS-IH-0610**  
62" T3 Lamp • 0.625 amps @ 120V

**AS-IH-0612**  
48" T3 Lamp • 0.49 amps @ 120V

**AS-IH-0611**  
33" T3 Lamp • 0.35 amps @ 120V

Mounting hardware

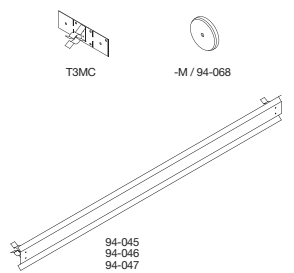

**T3MC**  
T3 UVC Lamp mounting clamp supplied with LCI system

**-M / 94-068**  
Magnet option (2 required per lamp)

**94-045 • 94-046 • 94-047**  
33", 48", and 62" UV light shield

## Basic LCI configurations, customizable to fit any air handler

Two-lamp assembly

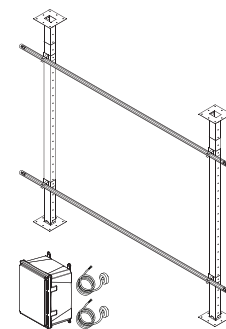

**VXP-120** Vertical supports (2)  
**LCI-2** Power enclosure  
**AS-IH-0610** UV-C lamps (2)  
**T3MC** LCI mounting clamps (4)

### Coil Disinfection

Four-lamp assembly

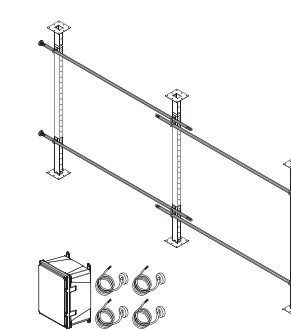

**VXP-120** Vertical supports (3)  
**LCI-4** Power enclosure  
**AS-IH-0610** UV-C lamps (4)  
**T3MC** LCI mounting clamps (8)

Six-lamp assembly

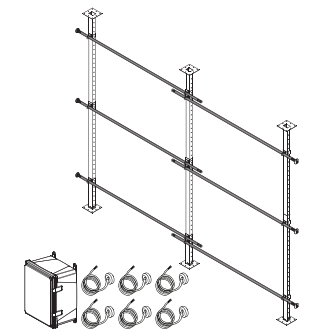

**VXP-120** Vertical supports (3)  
**LCI-6** Power enclosure  
**AS-IH-0610** UV-C lamps (6)  
**T3MC** LCI mounting clamps (12)

### Airstream Disinfection

Center-duct configuration

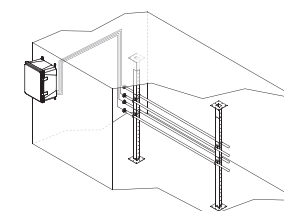

**VXP-120** Vertical supports (2)  
**LCI-4** Power enclosure  
**AS-IH-0610** UV-C lamps (4)  
**T3MC** LCI mounting clamps (8)  
**LCI-6** Power enclosure

Side-access configuration

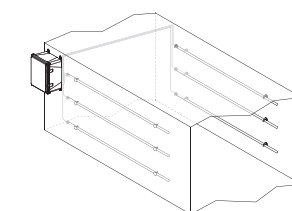

**AS-IH-0610** UV-C lamps (6)  
**T3MC** LCI mounting clamps (12)  
**-M** Mounting magnets (12)

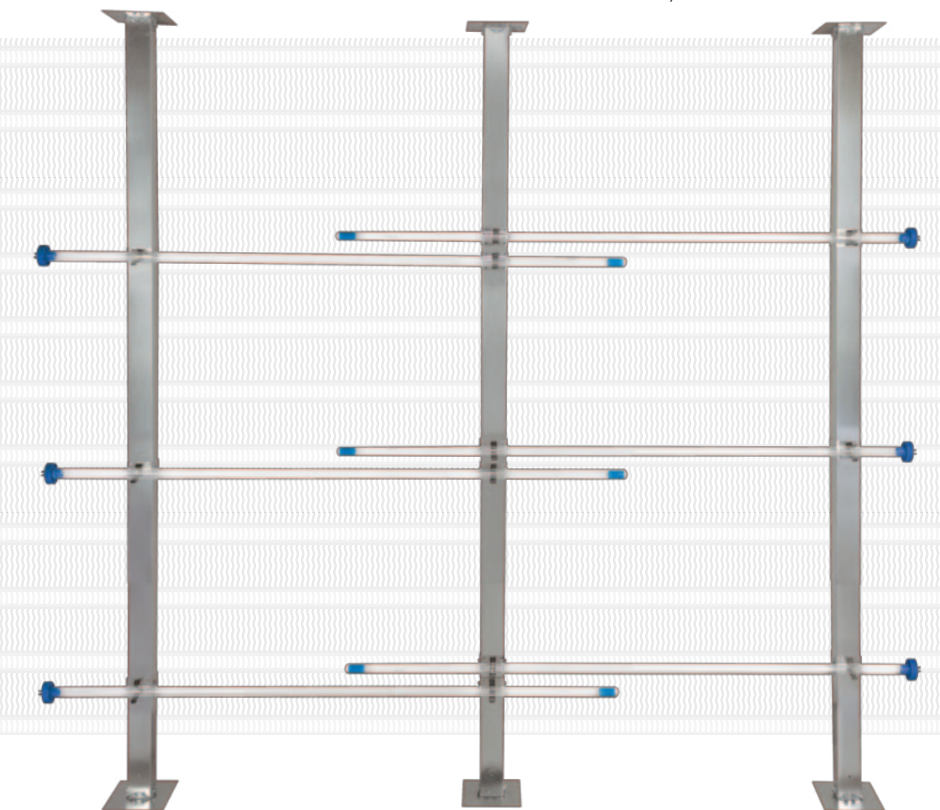

# Ultravation® UVMatrix™ PCO odor and VOC reduction

## Independent testing confirms disinfection performance

Viral challenge studies were designed by the independent testing firm **Innovative Bioanalysis, Inc. of Costa Mesa, California**, to determine the efficacy of the **Ultravation UVMatrix PCO** air and surface disinfection system against coronaviruses, specifically SARS-CoV-2. The validation of the results was confirmed in testing following industry and ASHRAE recommendations and guidelines. The results showed that **99.99% of the SARS-CoV-2 virus was deactivated on surfaces within 30 minutes of exposure** (see full report data at Ultravation.com).

## Creating healthier and productive indoor environments

The UVMatrix PCO purification system creates healthier and cleaner indoor air by breaking down air contamination in the HVAC airstream. The photocatalytic oxidation or PCO process is germicidal to intercept circulating microbes/pathogens of all types (killing bacteria and viruses in seconds) and will remove potentially harmful VOCs (volatile organic compounds), odors, and other airborne chemical compounds by breaking their chemical bonds.

## The process

The air purification modules are coated with a patented titanium dioxide (TiO<sub>2</sub>) + zinc (Zn) and silver (Ag) ion PCO formulation. The PCO formulation is energized by UV-C light, driving the interaction of the PCO formulation with airborne contamination, resulting in the breakdown of the molecular structure of the contamination into its non-harmful component parts. In the case of biological contamination, both the UVGI and the PCO formulation come into play—the UV-C light penetrating and destroying DNA and the PCO process reacting with and destroying cellular membranes.

## Versatile and expandable

The UVMatrix PCO series is designed for HVAC systems from 1,200 to 8,000 CFM. Two sizes are available to accommodate any HVAC configuration with a rate of effectiveness. The system can also power a second PCO module if VOC / odor levels call for it. Or, add a 12" or 17" high-intensity UV-C lamp for surface disinfection. UVGI disinfects the HVAC coil (which can significantly lower HVAC energy consumption), drain pan and other surfaces. It also works in tandem with the PCO module to create two disinfection zones in the HVAC airstream for an intensified reduction of airborne pathogens.

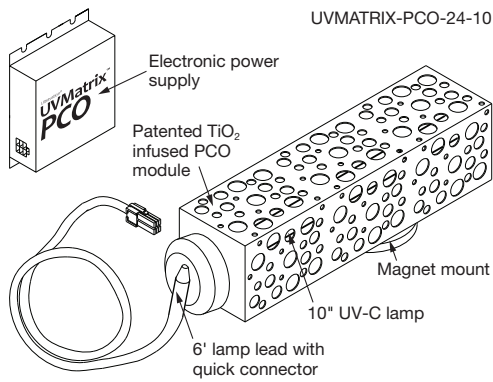

*UVMatrix PCO continuously cleans the HVAC air stream, reducing microbial populations, VOCs and odors.*

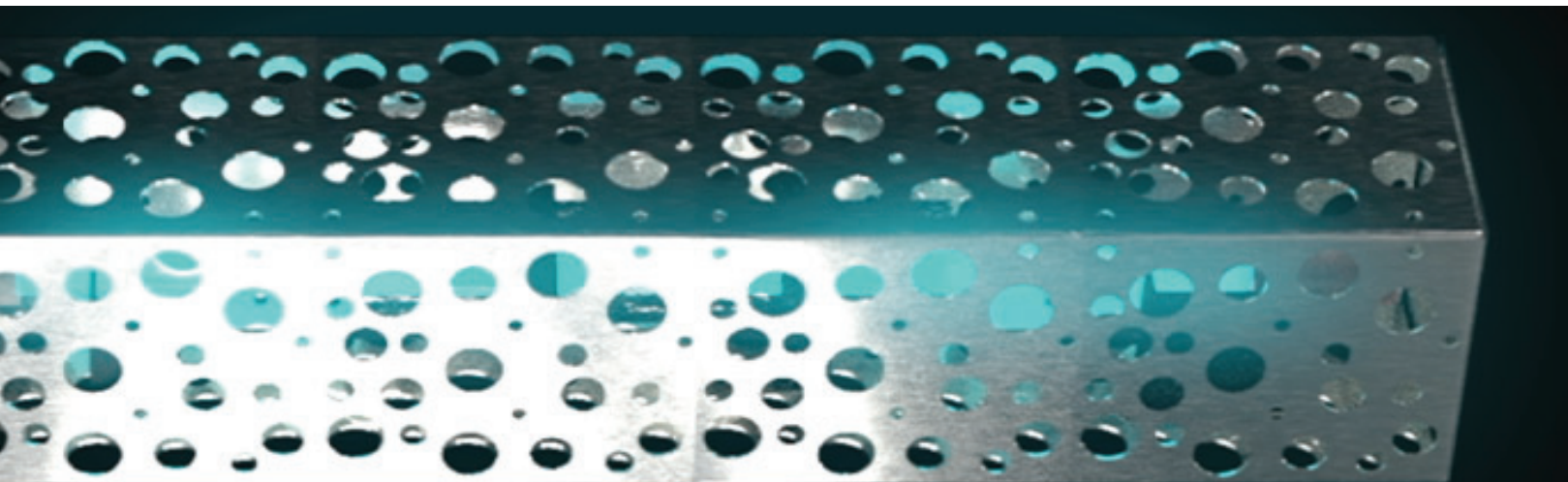

## UVMatrix™ PCO Features

- Two module sizes: 4" and 10"
- 18,000-hour lamp life
- 10-year system warranty (excludes lamp)
- 1-year UV lamp warranty
- Easy maintenance with extended two-year UV-C lamp replacement interval.
- Available T3™ enhanced lamp system for surface disinfection and additional pathogen reduction.
- Reliable and UVC-optimizing electronic power supply helps extend lamp life.
- Compact Power Supply: just 3.5" x 3.5" x 1"
- Available for 24, 120-277 VAC operation
- 6 ft. power cord (24 VAC models)
- Installation is straight-forward with pre-installed magnet mount design.

## Basic configurations

4" PCO Modules

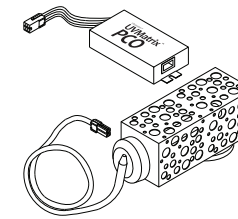

The 4" UVMatrix™ PCO system (UVMATRIX PCO-LV-4)

10" PCO Modules

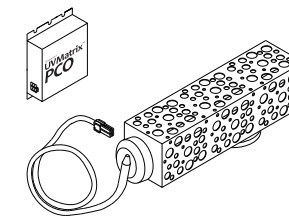

The 10" UVMatrix™ PCO system (UVMATRIX PCO-24-10)

Two 10" PCO Modules

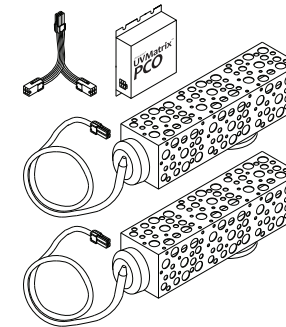

The UVMatrix™ PCO-24-2-10 features two 10" PCO modules that connect to the power supply using a Quick Connect Y Adapter.

10" PCO Module plus UV-C

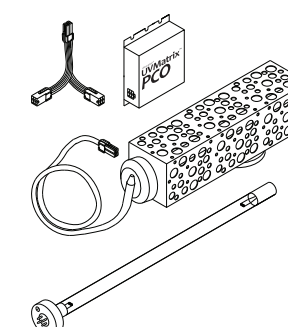

The UVMatrix™ PCO-24-10 features a PCO module and an EZ-Light 6P Germicidal UV-C lamp (UV lamp available in 12" and 17" lengths, and uses the Quick connect Y adapter to connect .

## Installs in any packaged system

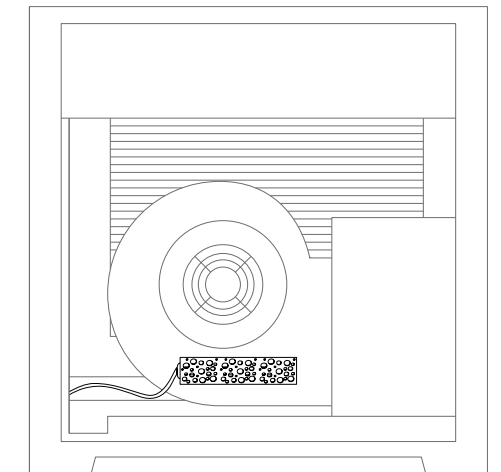
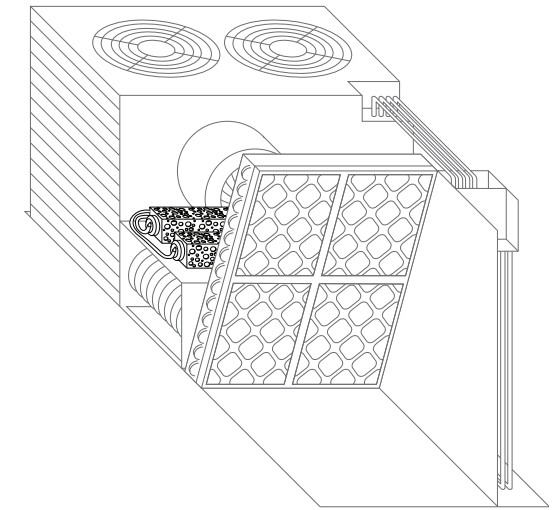

Additional configurations are available.  
All models available with a 120-277 VAC power supply or a 24 VAC power supply.

# Ultravation® UVMatrix™ CIS rapid pulse air ionization

Micro and nanoparticles have been found to have adverse affects on those with respiratory and cardiovascular issues—especially since they readily pass through natural respiratory defenses. Odors, VOCs and gases are made up of complex molecules.

Ultravation® UVMatrix™ CIS rapid pulse ion generator systems group nanoparticles into groups that quality filtration can capture. CIS ions react with complex molecular and biological contamination, decomposing it.

## Benefits include:

- Micro and nano-particulate capture
- Odor and VOC reduction
- Breakdown of smoke and airborne toxic chemicals
- Augmentation of UV-C disinfection to increase the reduction of airborne bacteria and viruses

Three configurations available to accomodate a wide range of applications. Installation options ranging from 4 ton HVAC systems to large air handlers. Applications include:

- |                            |  |                                  |                   |
|----------------------------|--|----------------------------------|-------------------|
| • Large office buildings   | • Nursing homes / elderly care centers | • Manufacturing                  | • Law enforcement |
| • Small and medium offices | • Animal facilities                    | • Medical and veterinary centers | • Prisons         |
| • Government buildings     | • Cruise ships                         | • Schools                        | • Nail salons     |
| • Animal facilities        |  |                                  | • Food service    |

## CIS36: Designed for large air handlers

The UV Matrix CIS 54-inch wide 12-pin ionizer (pictured below) can be installed directly in many air handlers. Using the optional VXP rack it readily fits virtually any large air handler to install a single or multiple units—usually on the return side of the HVAC coil.

Ultravation VXP rack is compatible for single or multiple unit mounting (see LCI UV disinfection systems, previous pages)

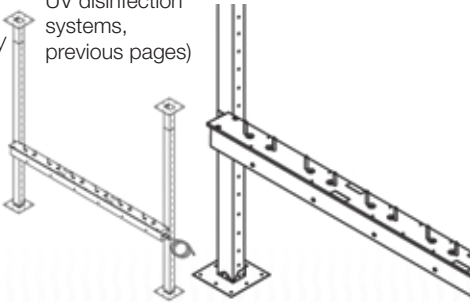

- 12 rapid pulse emitters
- Releases millions of positive and negative ions per second
- 20 ft. power lead
- Rack mount-able in large air handler
- For larger systems rack-mount multiple CIS units

**Sizing assistance:** Contact Ultravation for advice on unit configurations and placement for your particular building layout.

CIS-36  
54" wide

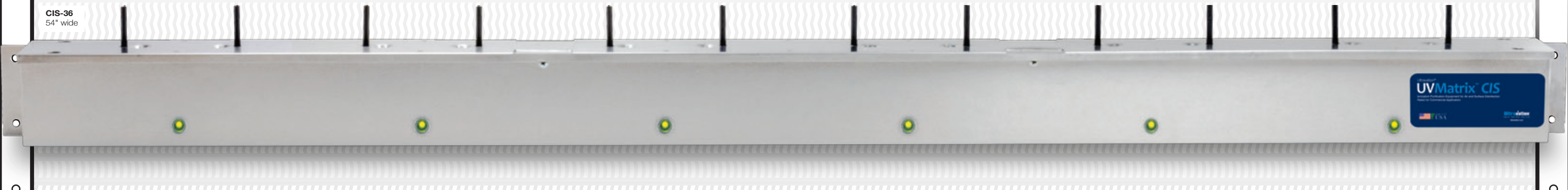

## Ultravation® CIS Ionization: How it improves the air



### Ultra-fine particulate reduction

Ions electrically charge micro and nanoparticles which attract into filterable groups, enhancing filter efficiency for small particulates

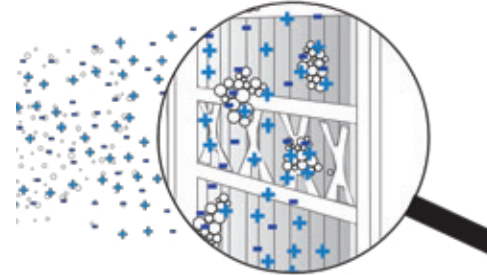

### Odor reduction

Ions react with odor / VOC molecules, disrupting molecular bonds, reducing them to the normal components of air.

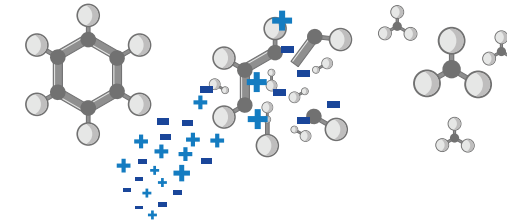

### Airstream disinfection

The electrical (+/-) charges of the released ions penetrate the membranes / surfaces of microorganisms, inactivating them.

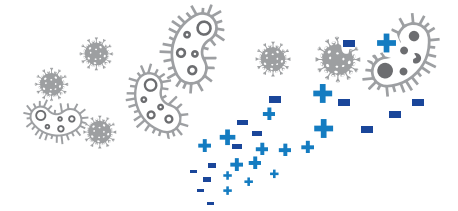

## CIS12: Ionization for 7-12 ton HVAC systems

The UV Matrix CIS-12 is a 4-pin ionizer that can be used singularly or in multiples.

- 4 rapid pulse emitters
- Releases millions of positive and negative ions per second
- Adjustable emitters to mount inside or outside the air handler
- Available magnet mounts for easy internal mounting

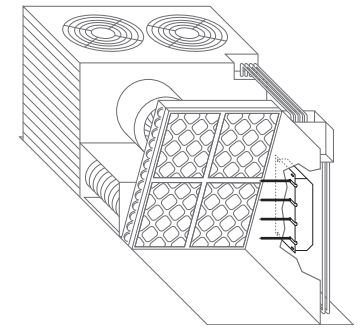

CIS-12

## CIS6: Ionization for 4-6 ton HVAC systems

The UV Matrix CIS-6 is a 2-pin ionizer that can be used singularly or in multiples.

- 2 rapid pulse emitters
- Releases millions of positive and negative ions per second
- Adjustable emitters to mount inside or outside the air handler
- Available magnet mounts for easy internal mounting

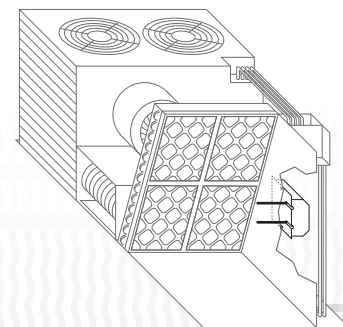

CIS-6

Ultravation®

# BIOGARDUV™ “Upper Air” UV system

Air disinfection for individual rooms and public spaces



Ultravation® BioGardUV™ germicidal ultraviolet air disinfection (UVGI) destroys airborne pathogens by creating a disinfection zone in upper regions of a room (above 7 ft.) using UV light. Available as 100% silent convection models or fan-assisted models with ion generation,

depending on the need. Air that becomes bio-contaminated and warmed in the lower part of a room (from respiration and other sources) naturally circulates to the upper regions, where it will be exposed to germicidal UV-C light, which kills airborne bacteria and viruses in seconds. To accelerate air flow, models with built-in circulating fans can be specified. Fan accelerated models (FS-22F and FS-33F) include bi-polar ionization that breaks down odors and airborne toxins, and facilitates microparticulate reduction while augmenting air disinfection. **Since the UV light field is restricted to areas above seven feet, the room is safe for occupancy while the air is continuously disinfected.** These systems do not produce ozone.

**BioGardUV™ is energy-efficient**, using no more power than a fluorescent lamp. Models with fans use slightly more power to create a quiet but controlled circulation of air.

**Two sizes are available** in both wall-mount and ceiling mount models. Ceiling mount models install flush-to-ceiling or can be hung with optional pendants. Ceiling mount models create two disinfection zones, front and rear.

**Sizing assistance:** Contact Ultravation for advice on unit configurations and placement for your particular building layout.

## Features:

- Focused 254nm germicidal UV-C wavelength
- 9,000 hour UV lamp life
- Galvanized steel construction
- Safety interlock switch
- Energy-efficient
- Powder-coat finish
- Optional bi-polar ionization

## UVGI is recognized by ASHRAE\*, the EPA and the CDC

UV has been proven in laboratory studies to achieve a 99.9% kill rate on static coronaviruses including SARS-CoV-2 in 2 seconds.

UV-C light is the only air disinfection technology that is supported as effective by ASHRAE.

ASHRAE's recommendation for airborne pathogen reduction: "Consider adding air treatment and cleaning devices such as UVGI (ultraviolet germicidal irradiation) in duct, plenums and air handling units and on the face of cooling coils."

— ASHRAE's online guide to pandemic preparedness - Develop a Preparedness Plan, Item 9

\*American Society of Heating, Refrigerating and Air-Conditioning Engineers

### UV effectiveness against various microbes

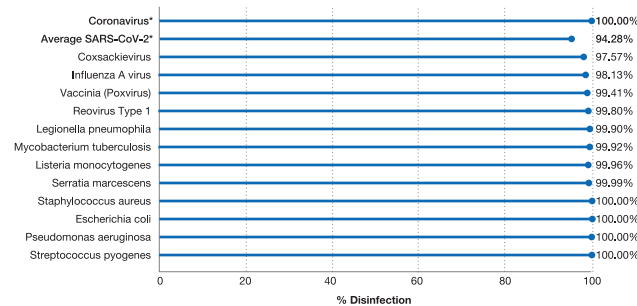

Percentage disinfection calculations are based on intensity at end of (9,000 hour) lamp life. \*There are many strains of coronavirus that have been identified. This chart lists just two.

## How BioGardUV™ FS-Series reduces airborne microbes in occupied rooms

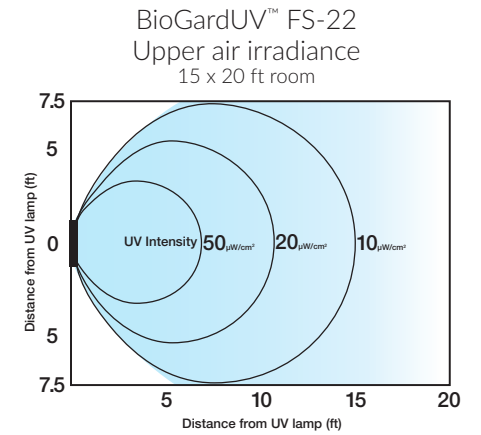
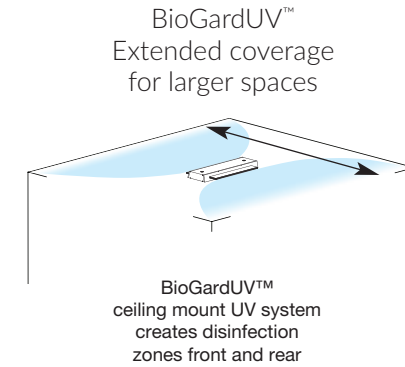
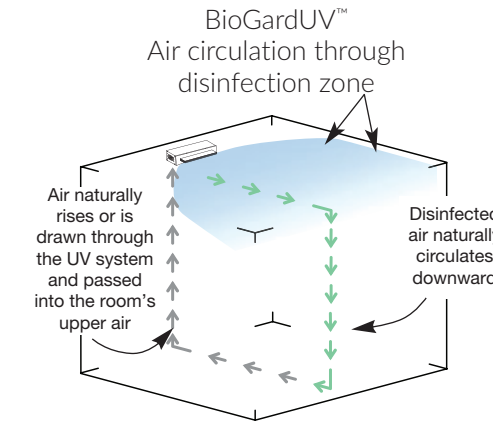

### BioGardUV™ Air Flow System (with fan and ionization)

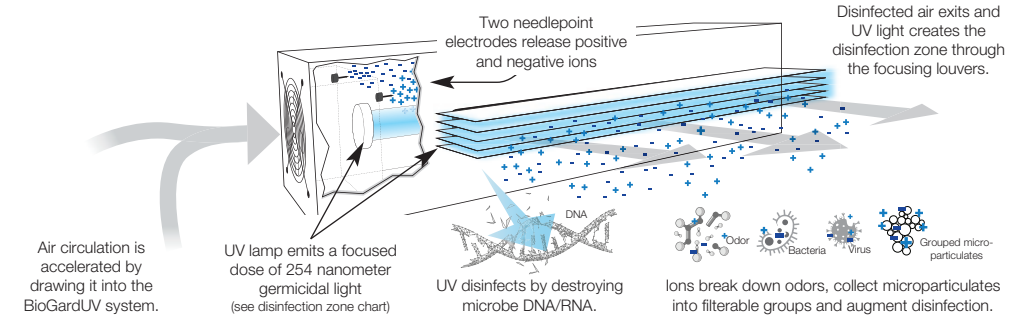

### Typical placement for various models

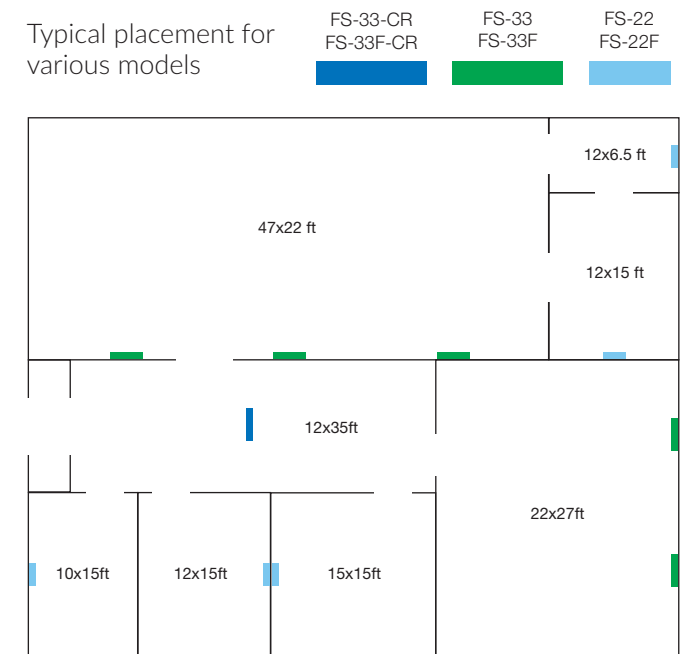

**Getting the right UV coverage:** Contact us for information and advice on the number of units required to meet your goals based on room size, and for placement suggestions

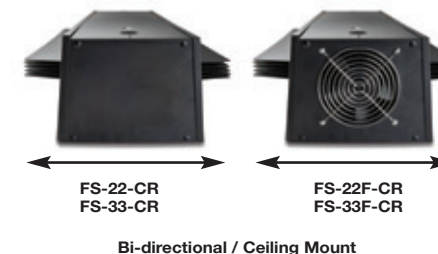

Ultravation®

# Residential IAQ Products: Creating healthier indoor environments at home

*We design and manufacture IAQ solutions covering the total range of indoor air pollution*

**Ultravation®**  
Better Air | Better Water | Better Living™

## Bi-Polar Ionization

Ultravation®  
**Orion™**

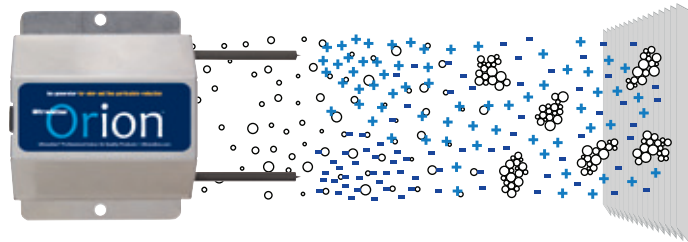

## Filtration

Ultravation®  
**ProgressiveMedia™**



## HVAC Interior Surface UV Disinfection

Ultravation®  
**UVC-Advantage™**  
Efficient and convenient all-in-one integrated UV-C disinfection system



Ultravation®  
**UltraMAX™ EZUV**  
Compact, remote power supply UV-C disinfection system



Ultravation®  
**UltraMAX™**  
Heavy-duty remote power supply with UV-C lamp monitoring



## Photocatalytic Air Purification

Active catalyst PCO purification

Ultravation®  
**UVPhotoMAX™**

Patented active and adjustable PCO air purification.



Carbon capture PCO purification

Ultravation®  
**UVCatalyst™**

Industry leading 3-Panel deep-bed activated carbon pollution capture with PCO air purification.



## Bi-Polar Ionization

Micro-particulates, viruses and bacteria are electrostatically grouped together for enabling capture in quality filtration.

## Filtration

High-efficiency MERV 11 and 13 performance. Hypo-allergenic, continuous fibers and pleated design. Rugged U.S. sourced galvanized steel cabinets with 10-year warranty.

## HVAC Interior Surface UV Disinfection

Keeps HVAC interior free of bio-growth 24/7. Prevents HVAC-sourced allergens. Bio-growth-free coils are efficient and save energy!

## Photocatalytic (PCO) Air Purification

PCO process removes harmful toxins and germs from the air. It also works in tandem with UV-C lamps to increasing airborne microorganism germicidal exposure time.

*Multi-technology solutions for comprehensive improvement of indoor air quality*

Ultravation®

# Solaris® IAQ Products:

## A unique *system approach* to maximizing indoor air quality



Bring cleaner air to your life™

SolarisIAQ.com

Solaris®: An Ultravation® brand

### The challenge of creating healthy air is multi-faceted

### A multi-technology, strategic approach meets the challenge

A Solaris® IAQ system combines several specialized air improvement devices in one system, with each device optimally placed in the HVAC airstream. As a system, the full spectrum of indoor air contamination is addressed and improved.

**Flexibility is key.** Solaris allows you to target the causes of a poor air quality situation with the right components. Combining specialized IAQ devices into an integrated system is an ideal way to meet the goals for reduction or elimination of targeted pathogens and non-organic contaminants and is a unique benefit of a Solaris IAQ system.

#### Analyze the need, create a solution:

Indoor air pollution runs from the visible to the molecular in size and in a variety of forms. It takes specialized engineering to develop sound methods for reduction in the various categories.

Ultravation designs and manufactures products for each category of pollution that can work independently or as an integrated system. As a system they are designed to complement each other to enhance the overall improvement in the freshness and healthfulness of the air you breathe and can even save energy.

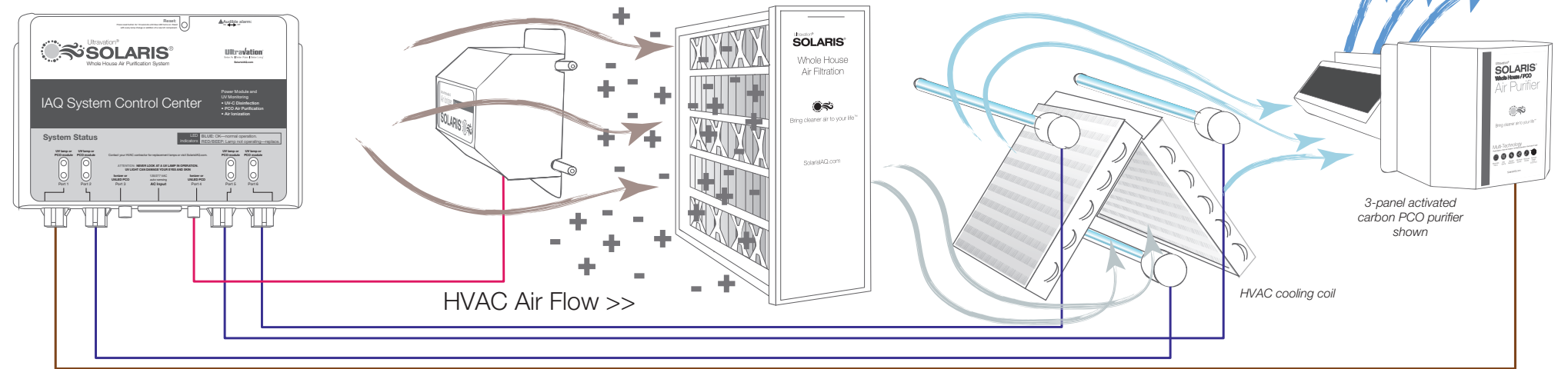
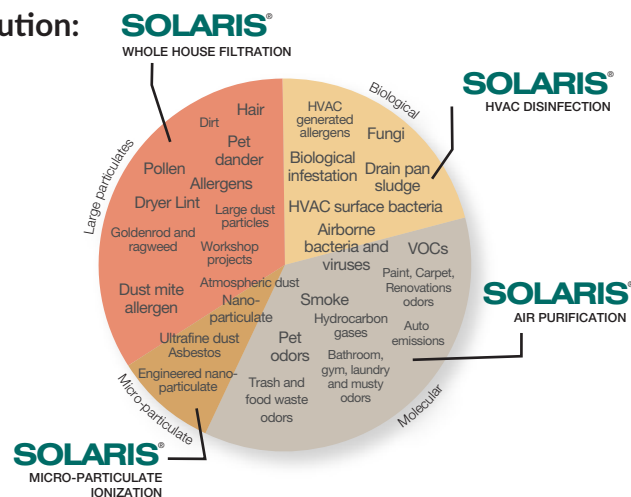

Cleaner, fresher air!

**IAQ System Control Center** operates electronics and monitors UV lamps (required in all Solaris IAQ Systems).

**Air-scrubbing Air Ionizer** groups micro-particulates for filter capture. Also disinfects filter fibers when installed adjacent to a filter.

**MERV 13 Filtration** for dust, dirt, lint, allergens, and 99% of all airborne particulates .3 microns and larger. Captures grouped micro-particulates when used with ionization.

**Up to 3 UVGI lamps** as needed to disinfect HVAC interiors which reduces cooling energy use and prevents HVAC-generated allergens. UV-C light kills bacteria and viruses in the HVAC airstream.

**PCO Air Purifier** breaks down odors, VOCs, toxic fumes, and also deactivates airborne bacteria and viruses and can provide a second dose of lethal UV light when UV-C lights are installed at the coil.

**Efficient, convenient, smart.** A central power module saves energy, simplifies the installation, and centrally displays UV lamp status. This allows uncomplicated installation of IAQ components at most effective HVAC locations.

### IAQ System Control Center

Solaris IAQ component central power module



### Bi-Polar Ionization

Air Ionizer for fresher air and reduction of micro-particulates. Installs in HVAC return, supply air or both depending on the need.



### Whole House Filtration

Filters feature more than 25 square feet of pleated, layered and hypo-allergenic MERV 13 filter material. Rugged U.S. sourced steel construction.



### UV Disinfection

Germicidal UV lights with Ultravation T3™ design emit 40% more germicidal UV without additional power consumption.

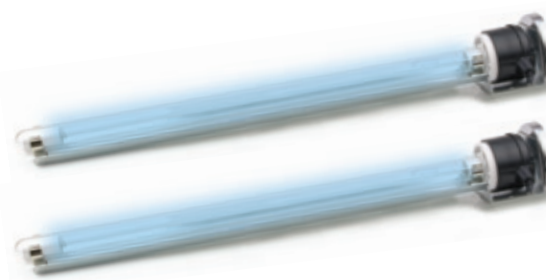

### Photocatalytic (PCO) Air Purification

PCO air purifiers in two configurations have an industry leading ability to remove odors, VOCs, and airborne toxins and pathogens.

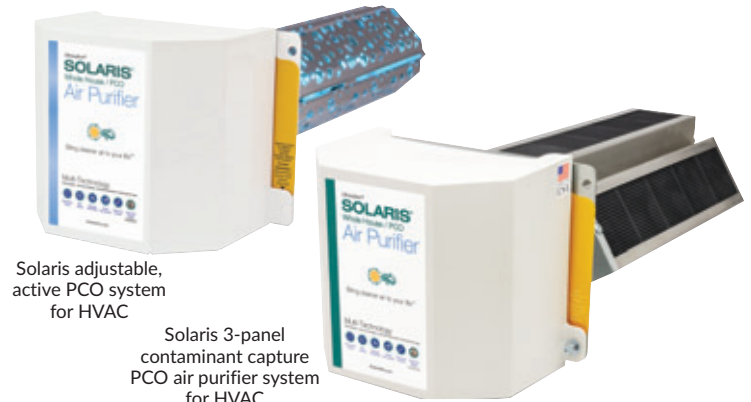

Solaris adjustable, active PCO system for HVAC

Solaris 3-panel contaminant capture PCO air purifier system for HVAC

Ultravation®

# UVMatrix™ Specialized Applications

## Ultravation® UVMatrix™ M-Series

Provides maximum UV-C germicidal disinfection for **ductless air conditioning units** found in hotels, motels, medical offices, homes, apartments, and condominiums.



## Ultravation® UVMatrix™ ClearCubes™

Dual-bandwidth UV system for **ice machines**, available in 9" and 18" lengths, continually applies germicidal UV-C light to destroy bacteria and all other bio-growth for safer, fresher ice.



## Ultravation® UVMatrix™ 4X-Series

UV-C disinfection for outdoor and **rooftop HVAC applications** with remote monitoring available.



## Ultravation® UVMatrix™ EZ-Light

Design accommodates **ice machines and PTAC systems** to kill bio-growth and prevent "dirty sock" odors from contaminated cooling coils. Lamps are available in 22", 33", 48" and 62" lengths to maximize installation flexibility.

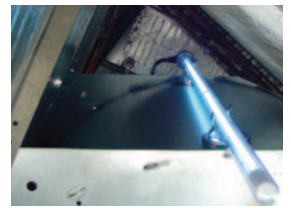

## Ultravation® OEM and Private Label Products

We offer a full range of manufacturing services to meet your specifications. We also offer custom branding and full private labeling for various IAQ products. Contact [sales@ultravation.com](mailto:sales@ultravation.com)



Member:



EPA establishment number: 074725-VT-001

# Ultravation®

Better Air | Better Water | Better Living™

Ultravation.com • +1 866 468 8247  
sales@ultravation.com

Manufactured in the USA by **Ultravation, Inc.**

Ultravation's T3™ system is protected by US patents 6,809,326B2 and 6,838,057B2  
Ultravation's SI-Series™ system design is protected by U.S. patents 7419642B2 and 682805B2

Copyright © 2022 Ultravation, Inc. All rights reserved. • ISVT 13177